

This zoom lens is designed for use with the DLP™ projector. The lens makes it possible to vary the projection distance by changing the focal distance.

**NOTE:** Please use the lens only on the specified Panasonic DLP™ projector.

**Specifications**

F value:	2.5
Focal distance (f):	28.8 mm–38.4 mm
Dimensions (W x H x D):	130 x 130 x 259 mm (5-1/8" x 5-1/8" x 10-3/16")
Weight:	4.6 kg (10.1 lbs)
Compatible models:	PT-D10000, PT-DW10000, PT-D7700, PT-DW7000
Throw ratio:	1.5–2.0:1 for PT-D10000/D7700, 4:3 and 16:9 aspect ratio 1.4–1.8:1 for PT-DW10000, 16:9 aspect ratio 1.5–2.0:1 for PT-DW7000, 16:9 aspect ratio

The throw ratio is an approximate value calculated by dividing the screen width by the projection distance. DLP and the DLP logo are trademarks of Texas Instruments. Weights and dimensions shown are approximate. Specifications subject to change without notice.

**Dimensions**

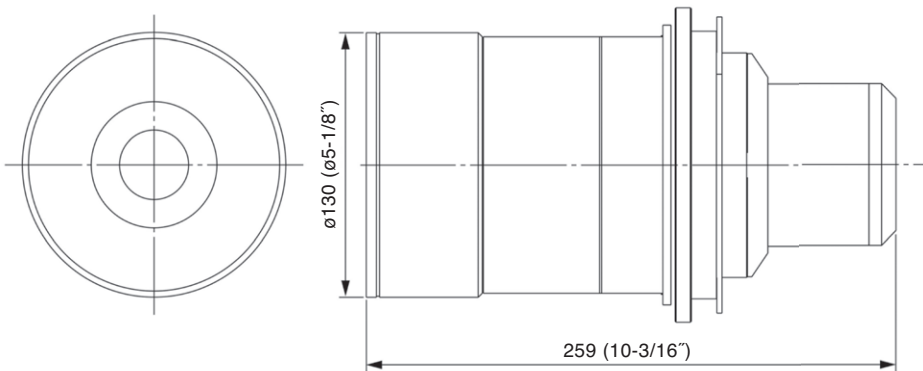

The illustration shows the lens attached to the PT-DW10000/D10000.

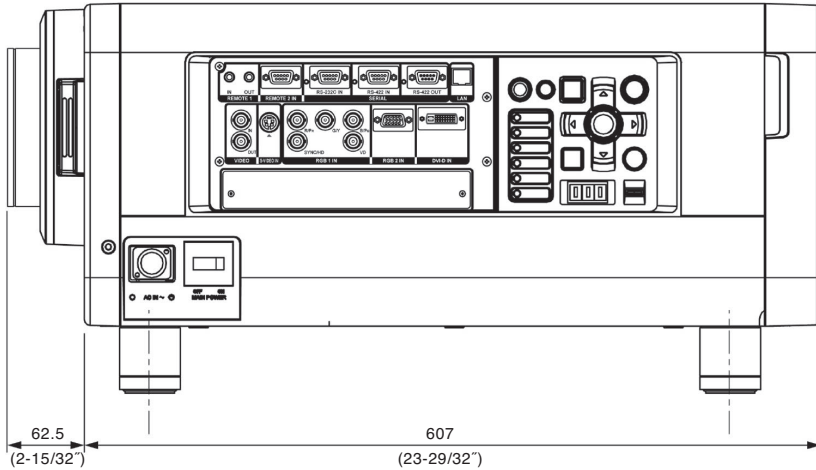

The illustration shows the lens attached to the PT-DW7000/D7700.

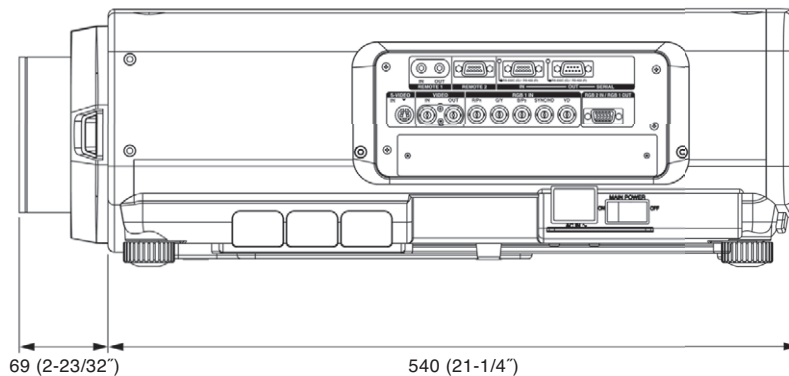

unit : mm (inch)

NOTE: This illustration is not drawn to scale.