



AVOLITES

CELEBRATING 40 YEARS OF  
TOTAL VISUAL CONTROL  
FROM ROCK TO OPERA

POWERED BY  
AVOLITES  
**titan**



## LIGHTING CONTROL



*Sapphire Touch*



*Arena*



*Tiger Touch II*



*Tiger Touch Fader Wing*



*Quartz*



*Titan Mobile*



*Mobile Fader Wing*



*Titan One*



*Titan Net Processor*



*Titan Net Switch*



*Rack Splitter*



*Truss Splitter*

## MEDIA CONTROL



*Infinity RX*



*Infinity R*



*Licence Keys*

## DIMMING CONTROL



*ART2020*



*ART2000 T4*



*ART2000TV Series*



*Power Cube*

**Designed and Manufactured in the UK**

Full product information can be found at [www.avolites.com](http://www.avolites.com)

+44 (0)20 8965 8522  
sales@avolites.com

Avolites  
184 Park Avenue  
Park Royal, London  
NW10 7XL  
United Kingdom

## Notable Titan Productions

Hozier UK & US Tour  
Indian Premier League Cricket Closing Ceremony  
South East Asia Games  
Red Bull Culture Clash  
Arcade Fire Reflektor World Tour  
Katy B UK & Europe Tour  
Blur World Tour  
Level 42 UK & Europe Tour  
Roberto Carlos Americas Tour  
All Time Low & Good Charlotte UK Tour

## Notable Ai Productions

London Olympics Opening & Closing Ceremonies  
Sochi Winter Olympics Closing Ceremonies  
Bon Jovi "Because We Can" World Tour  
Peter Pan Theatrical World Tour  
Electric Daisy Carnival, Las Vegas  
Arcadia, Glastonbury Festival & Thailand  
Eric Prydz EPIC 4.0 North America Tour  
Coldplay World Tour  
Latin Billboard Awards  
Childish Gambino World Tour

## Total Visual Control

National Day Parade - Singapore  
South East Asia Games  
Arcadia at Ultra - Miami  
Omnia - Las Vegas  
Jewel - Las Vegas  
The Script World Tour  
Cuckoo Nightclub - Piccadilly, London  
Nottingham Trent University  
Hunan Satellite TV Station - China  
The White Club - Dubai



Eric Prydz - EPIC 4.0 American Tour Phase 1  
2 x Ai S4 - Main and Back up Servers  
Production Directors & Ai Server Suppliers - RES  
Supported by PRG USA | Photo: Rukes



# SAPPHIRE TOUCH



## Performance engineering for instant live access

The Sapphire Touch is high performance, with more submasters, more flash and executor buttons, and the power to control the larger, more challenging shows.

- 45 touch sensitive, motorised, automated master playbacks
- Massive wide screen programming windows
- Fast, live and hands on attribute controls
- Unique Tricolour illuminated tracker ball with Z axis control to give fast control of distance related attributes – zoom, iris and focus
- 8 Physical DMX, up to 16 over ArtNet or streaming ACN – 8192 channels
- Built in UPS battery back-up
- 100% brighter, vibrant 15.6" touch screens
- Dual etherCON port
- Direct SMPTE in
- Supports Titan Network Processors for DMX expansion up to 64 universes
- Dedicated theatre cue stack control
- Huge programming surface – Capacity for 2 external touch screens/wings
- 20 programmable macro buttons
- Screen articulation
- Connectivity with Sapphire Touch Wing
- Expandable fixture library for over 14,000 devices
- MIDI in, out and through
- Trigger input
- Compatible with Titan Remote (Wi-Fi access point required)
- Connect up to two Sapphire Touch Wings to each Sapphire Touch console

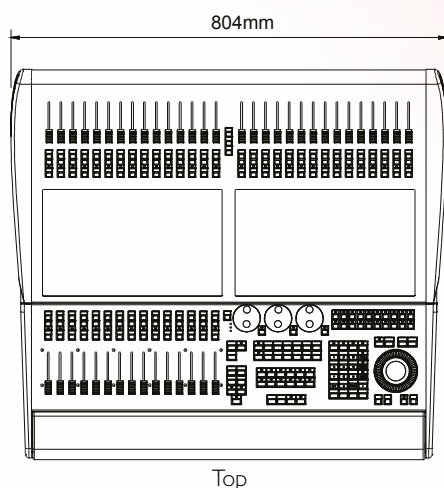

Top

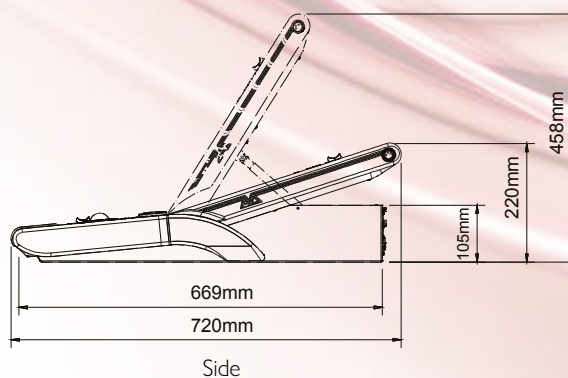

Side



Expandable with Tiger Touch Fader Wing



## More live control than ever before...

The Avolites Arena is the ideal desk for festivals, theatres and anywhere that a larger control surface is required. It combines the popular interface of the Tiger Touch II with more live control than ever before.

Alongside the vibrant main display, a second touch screen provides an additional workspace window, also labelling the adjacent macro buttons and rotary pots. These fully assignable playback encoder pots, allow intuitive control of channels and effects. The six LCD screens display electronic legends for 30 faders, for speedy access to all your playbacks, fixtures and palettes.

The Arena has a TNS built in allowing the console to include a brand new optical output, enabling fibre connections directly from the console, with no signal loss over long distances, from front of house to the stage – essential for low latencies in large and outdoor venues.

Offering seamless Multi User compatibility, the Arena can be used as master, back-up or extra programming surface, considerably cutting your programming time by allowing multiple Titan programmers to work simultaneously, before the main console takes charge.

- 40 precision playback faders in three pageable groups
- 20 programmable macro executor buttons
- 3 metal shaft optical attribute encoders
- 4 optical playback encoder ports
- 15.6" vibrant main touch screen with brightness control
- 7" vibrant secondary touch screen
- 6 mono LCD screens for digital fader legends
- UPS battery back-up
- New six-position articulation stand
- Ergonomic trim and carry handles
- Robust stainless and zinc treated steel construction – built for life on the road
- OpticalCON Stage link output, with an optional second link
- 8 physical 5-pin XLR opto-isolated DMX out, up to 16 universes over ArtNet or streaming ACN – total of 8192 console channels
- Compatible with the Titan Net Processor – up to 64 universes, total of 32, 768 system channels
- Sound to Light
- Supports multi-band audio triggering
- 4 etherCON Gigabit primary network connection with a battery maintained managed switch supporting Titan Net, ArtNet and streaming ACN
- 1 etherCON Gigabit secondary Network connection for Titan Net, ArtNet and streaming ACN
- 1 standard OpticalCON stage link output, to connect to industry standard network switches with optical support
- SMPTE Timecode/LTC input 3-pin XLR (transformer isolated)
- Trigger inputs on 1/4" jack, suitable for foot switches
- Audio in on stereo 1/4" jack for Audio Triggering
- Headphone 3.5mm jack conveniently placed on the front panel
- 4 USB3 ports – 1 front, 3 rear
- DVI-D for external display
- 2 x 3-pin XLR dimmable lamp connectors
- MIDI in, out and thru
- Compatible with Titan Remote (Wi-Fi access point required)
- Optional extras: Flight Case, Dimmable Lamp x2 and Cover

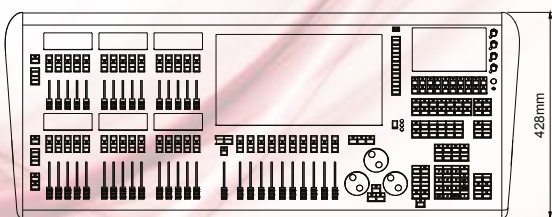

Top

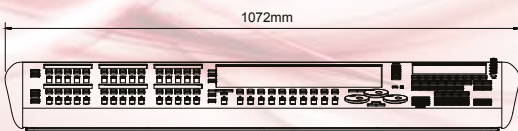

Front

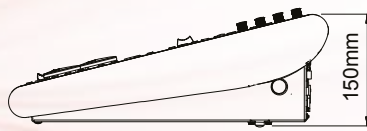

Side



Optional Titan Network Switch - Details p.10

# TIGER TOUCH II



POWERED BY  
**titan**

Expandable with Tiger Touch Fader Wing

## The Most Specified Titan Console

Now featuring a clear, 100% brighter touch screen, more powerful processor, and faster graphics engine, the Tiger Touch II is the most specified Titan console.

- Live 'hands on' and Cue List control
- 100% brighter, vibrant 15.6" touch screen
- 4 Physical DMX, up to 16 over ArtNet or streaming ACN – 8192 channels
- Supports Titan Network Processors for DMX expansion up to 64 universes

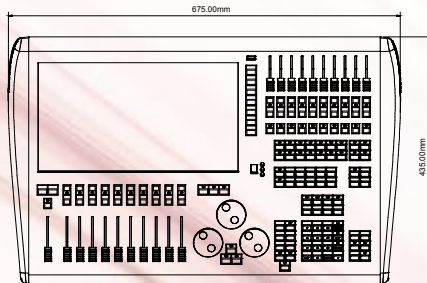

Top

- 20 submasters for Cues, Cue Lists and sequences
- Show file compatibility with Titan console range
- 10 direct Macro buttons and Macro library
- Support of ArtNet, CIP and streaming ACN
- Expandable Fixture library for over 14,000 devices
- Powerful processor, faster graphics, SSD drives and UPS fitted
- Conveniently located front panel mounted USB
- Direct SMPTE in
- Trigger input
- Compatible with Titan Remote (Wi-Fi access point required)
- 30kg in flight case

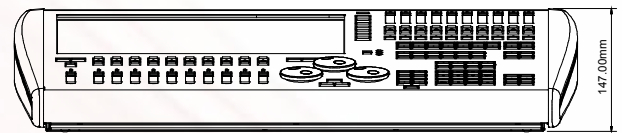

Front

## Tiger Touch Fader Wing

Expand your control surface with 30 additional faders for instant access to all of your playbacks, fixtures and palettes. Programmable macro buttons and independent paging control make for intuitive operation of world-class shows. Each fader has an electronic legend on a back lit LCD.

- 30 precision playback faders
- Each fader electronically labelled with an LCD screen
- Independent paging control for each row of 15 faders
- 60 user configurable flash or solo buttons
- 2 programmable macro buttons
- Independent pages for each row of faders
- Also compatible with Expert Pro, Sapphire Touch and Arena

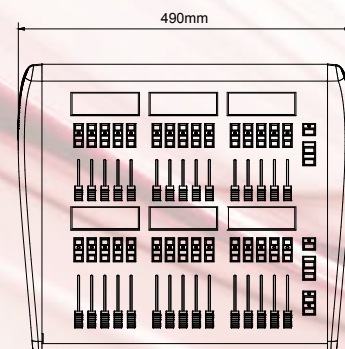

Top



Front

Side



Expandable with Titan Mobile Wing



## The Full Power of Titan, Anywhere...

Quartz is the newest addition to the Titan Mobile family, complete with on-board processing and a bright, clear 12.1" screen, in our smallest full-featured console. Super compact, measuring only 42.5cm wide, the Quartz is the ideal companion for all your lighting projects, from touring and festivals to clubs and one-offs.

Featuring the same high quality faders and hardware you've come to expect from Avolites, the Quartz can go anywhere you can, ideal for life on the road.

Offering full compatibility with Multi-user, the Quartz is also perfect for use as a back-up or extra programming surface, cutting your programming time. Quartz is ready to benefit from multi band Sound to Light Triggering functionality, offered in Titan version 9.

- Super compact form – just 42.5 cm wide
- Expandable with Titan Mobile Wing through dedicated USB port

- 4 physical DMX, 5-pin XLR connectors
- 16 DMX universes from the console – 8192 channels
- Compatible with Titan Net - up to 64 universes
- Gigabit Network port for Titan Net, Artnet and streaming ACN
- Built in MIDI input
- 10 precision playback faders
- 3 high quality optical encoders
- 20 programmable executor buttons
- Bright and vibrant 12.1" angled touch screen with brightness control
- Supports multi band audio triggering
- Sound to Light
- Headphone output
- Robust construction – built for life on the road
- Conveniently located front panel mounted SuperSpeed USB3 port
- Compatible with Titan Remote (Wi-Fi access point required)
- Optional extras: Flight Case, Portable Travel Case, Dimmable Desk Lamp and Cover
- Console weight 8.0 kg, weight in flight case 16.75 kg

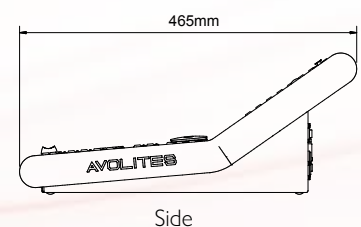
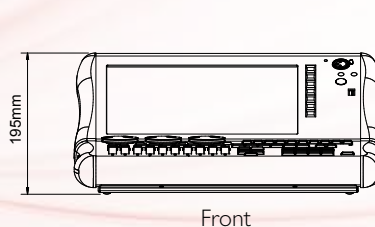
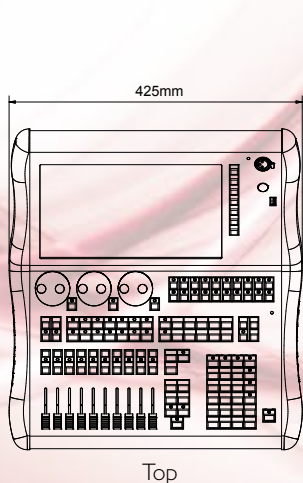

# TITAN MOBILE & TITAN MOBILE WING



POWERED BY  
**AVOLITES**  
**titan**

## The Power of Titan in its Most Concentrated Form!

Avolites Titan Mobile binds the awesome power of Titan software with a compact and lightweight unit that connects to your laptop to produce a fully featured moving light control system. Small enough to carry as hand luggage, large enough for complex shows. Shows transferrable to and from any other Titan console without any restrictions.

- 10 Playbacks with assignable controls
- 20 direct access workspaces, macros and executors
- 4 Physical DMX, up to 16 over ArtNet or streaming ACN – 8192 channels
- Supports Titan Network Processors for DMX expansion up to 64 universes
- USB powered – no need for mains connection
- Fast, live and hands on attribute controls
- Fast to programme and easy to use
- Weight 4.9 kg

### Titan Mobile Wing

- 20 precision playback faders
- 30 programmable executor buttons
- Paging control
- Dedicated work space window in Titan
- USB powered - no need for mains connection
- Weight 4.5 kg
- Compatible with all Titan consoles (except the Titan One)

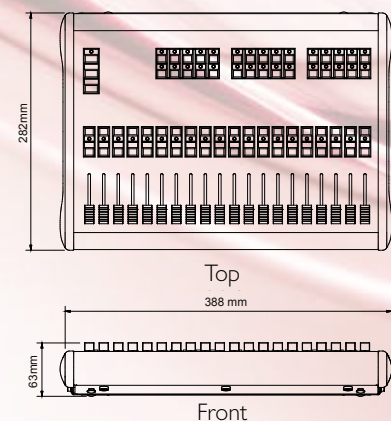
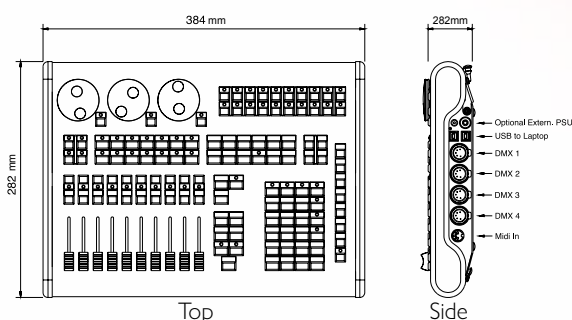

\*Laptop not included





## Titan One is the Cost Effective Solution for Your Entry Level Lighting Application

**Fast and Intuitive control of intelligent lighting, Dimmers and LED effects from one on screen console.**

The Titan One USB DMX dongle allows the user to output one line of DMX with the full functionality of Avolites Titan Software.

Access powerful features such as Pixelmapper, Quicksketch, Media Clip Select, Attribute Control, Blades and Shape Generator. Titan One allows you unlimited usage which gives you uninterrupted programming and playback time.

**Global Guide Pricing:  
£150 €220 \$250  
Contact your local distributor for  
educational discounts, training and support**

- Live music events – use the on-screen faders or touch screen flash to control and interact with your performance. Live, timed, Picture Palettes enable live busking at your fingertips
- Corporate events – Titan One provides centralized control of media servers and multi-cell LED fixtures. Display your client's logo instantly with the Pixel Mapping tool
- Museums, Retail and Son et Lumieres all run fully automated, scheduled playback from the time of day cue control
- Theatre and Drama – benefit from 'Move in Dark', Hot Key 'Go Button' control and fast plotting via keyboard syntax
- Clubs and bars – easy to use visual programming. Control any fixture with the huge, built in fixture library
- TV and video studios - Live Edit and Update as well as Channel Output Monitor produces seamless production workflow
- On board immediate context sensitive help for whenever you need a little assistance
- Technicians tool – Test, Address and Fault Find your rig from backstage or the warehouse. Titan One provides a full functionality diagnostic tool
- Allows you to edit on the move, then run the performance from any Titan system
- Fully networkable with any Titan product

# TITAN NET PROCESSOR & TITAN NET SWITCH

## Titan Net Processor

The backbone of your system. Unleash the power of your Titan system with the Titan Net Processor. TNP not only increases the capacity of your system to up to 64 universes, but also offers seamless integration with Titan Net back up, and spreads the processing load for heightened reliability of today's channel intensive shows.

- 16 universes processed per TNP
- 8 DMX outlets, protected by optical and galvanic isolation
- 2 Gigabit ethernet ports to output ArtNet or streaming ACN front fitted as standard. Move to rear option
- Built in UPS - Maintain the network during mains outages
- Bright high resolution touch sensitive LCD screen for fast local control
- Built in UPS, 5 x 4 minute sessions without charging
- 100-240 V AC mains input range
- Processing unit is housed in a shock mounted frame
- Rugged steel enclosure, 19" rack mountable
- Distributed Pixelmap rendering engine



- Compatible with all Titan consoles (except the Titan One)
- Fast, low latency for live applications
- Network Time Synchronisation
- Two USB sockets at the front

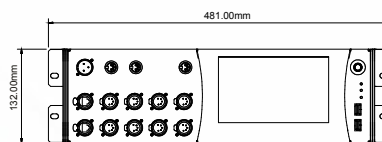

Front

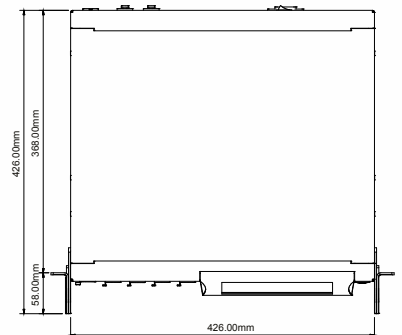

Top

## Optical Titan Net Switch

For when reliability counts. The Optical TNS is perfect for connecting FOH to stage using cat5e ethernet cables for distances under 80 m, and an Optical input for fibre connections over distances exceeding 80 m. The 1 Gigabit network switch also features a built in UPS to ensure the stability and resilience of your show setup.

- 1 opticalCON optical input
- 6 ethercON outlets with status indication above the outlet for easy status checking
- Integrated LCD display for easy configuration and status reporting
- Built in UPS - Maintain the network during mains outages
- Can be used by direct connection to the Avolites Arena console or in pairs to any Avolites Titan console
- Connect FOH to the stage with cat5e ethernet cables, up to 100 m dependent on cable quality
- The Optical port connection can be used to bridge distances larger than the 100 m ethernet, depending on the fibre used this can be 225 m-550 m (multimode) or 10 km (single mode)

### Switch capacity

- Ports are usable at 10,100 and 1000 Mbps
- Bandwidth: 20 Gbps full duplex
- Network latency @1000Mbps: Less than 4  $\mu$ s

sales@avolites.com



### Front

- 1 opticalCON optical input at the front
- 6 ethercON outlets with status indication above the outlet for easy status checking
- 1 status indication for rear mounted ethercON outlet

### Rear

- 1 ethercON outlet with status indication above the outlet for easy status checking
- IEC mains inlet compatible with the 'IECLock™' connector
- Compatible with all Titan consoles (except the Titan One)



Top

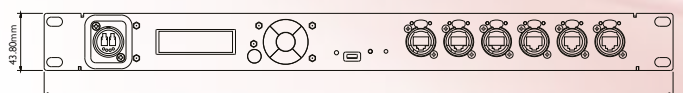

Front

www.avolites.com



All Time Low & Good Charlotte - Back to The Future Hearts UK Tour 2016  
2 x Sapphire Touch (Main & Backup)  
LD: Jeff Maker | Photo: Adam Elmakias

# TITAN FEATURES

## Key Frame Shapes

Introducing the amazing Key Frame Shapes, providing the capability to create spectacular effects from scratch. Using palettes or the programmer to define the frames, and powerful tools such as transition curves, phase and spatial direction, it is possible to create radically different looks for each channel in seconds. Synchronise these together for dramatic impact. Integrate Pixel Mapper effects with Key Frames using one simple interface.

## Multi User Networking

Connect multiple consoles together to work collaboratively or independently on the same show. A show can have multiple users, each with their own User Settings, Handle Worlds and Selected Key Profiles. With Multi User, consoles can still be used as backups.

Backstage techs can exchange, reset or fault find on fixtures, or even patch in floor packages, without interrupting programming. Palettes made or edited on one console automatically update to other connected consoles.

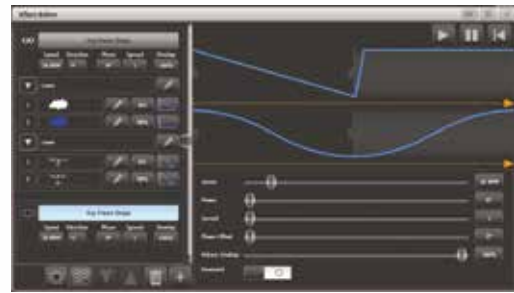

Networking of the outputs using the TNP increases system capabilities to up to 64 DMX universes, catering for even the largest world class spectacles. All of this can be used in conjunction with Titan Remote!

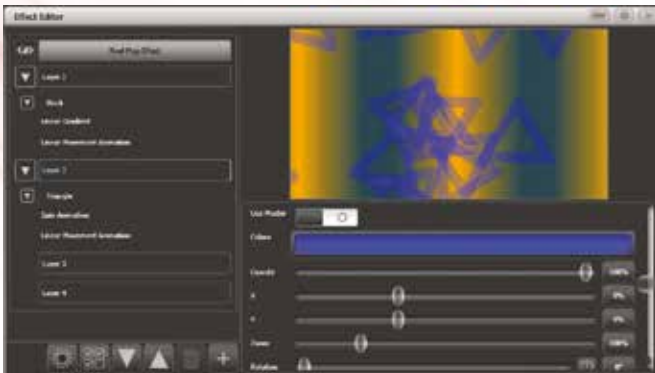

## Unmatched Pixel Mapping Capabilities

The industry's best pixel mapper allows complex multi-layer effects made in record time, across all fixture groups, as if they were one entity. Create and animate pre-programmed or custom content using Avolites' unique Quicksketch tool and image import. Use Gradient Fill to create smooth, soft edge transitions and exciting layered effects, now even quicker using cross-layer copy and move functions.



### Align

Effortlessly copy values across fixtures, either in a recurring pattern or a smooth fade.

V10



### Pixel Mapper with Motion Blur

Avolites' industry-leading pixel mapper gets even more powerful with the new motion blur effect in Titan V10, allowing for even more creative possibilities.

V10



## 3D Visualiser

Titan features a new full 3D visualiser powered by the Capture engine. Create and edit your show right inside the Titan interface. Lay out your fixtures in the space using your console's encoder wheels.

## Offset

Set an offset for any attribute of any fixture to fix common issues such as incorrectly rigged fixtures.

## Flexible Colour Mixing: Up to Seven Channels



Get maximum punch and more accurate colours from your LED fixtures, thanks to new, four-channel pixel mapping and colour mixing.



## Titan Remote

For fast fixture focusing or letting someone else update palettes while you update show data. Program edit or play back cues lists or sequences.



## Quicksketch

Quicksketch icons are fast to find during show time. Create custom icons instantly with Avolites' unique Quicksketch drawing tool.

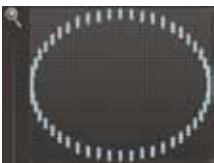

## Group Layout Auto-Arrange

New tools for quickly arranging fixtures in rectangular, circular and triangular layouts, when moving all fixtures or a selection.



## Audio Triggering

Trigger show content using seven-band audio triggering. (Quartz & Arena only).



## Global Palettes

Global palettes are importable between shows, and allow users to apply information universally to all fixtures.



## Nested Palettes

Create palettes which reference information from another palette. When the originals are updated, they will also update the nested palette.



## Show Library

Quickly access and organise all of your show data from one central location including; fixtures, palettes and playbacks.

## Powerful Cue Lists

Expansions to Titan's tracking now make it possible to track changes forwards and backwards. Cue lists now offer cue-only changes, and you can filter data in cue view to show only relevant information. Move-in-Dark makes for effortless moving light programming. MIDI Show Control allows the show to be run by the stage manager using Q-lab.

## Undo V10

Massively speed up programming with comprehensive Undo functionality. Undo almost any action on the console including; delete, merge, move and loads more. View history in the new undo window, and click any point to undo back to that action.

V10



## Freeform Workspaces

No longer restricted to just 4 workspaces per screen, pick any position and size for your windows in seconds and store them to your workspaces for quick access to the information you need.



## Group Intensity Masters

Fast control of entire groups of fixtures. Balance group intensities for TV or film or increase all Beam lights and reduce all washes on your live production.



## Show Import

Quickly create new shows from the best parts of your past productions.



## Set List

Cue pages can now follow the shows running order – no matter how late you are given the set list. Display helpful notes like songs, follow spot colours or operator cues.



## Exchange Mapping

Fixture exchange is revolutionised with a unique visual, Attribute Mapping System. Customise any fixture exchange to fit your needs; for example, old Gobo 1 to new Gobo 3.



## Keystone and Blade control

Control Keystone or Blades with intuitive graphical workspace.

V10

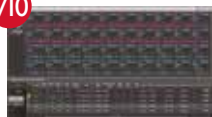

## Channel Intensity Grid

See all your intensity values in one place with V10's Intensity Grid. This clearly shows levels, source of information, whether increasing or decreasing and tracking information.



## Clip Select

Video Media Integration with instant multilayer patching and Video Clip Selection by image preview. For servers supporting CIPF.

## Show Reports

Create a cue list hard copy for the director or arrive at the venue with your rig pre-patched by sending in advance your fixture patch to the venue crew.



Sochi Winter Olympic Games

RES - S6 Media Server

Tiger Touch II



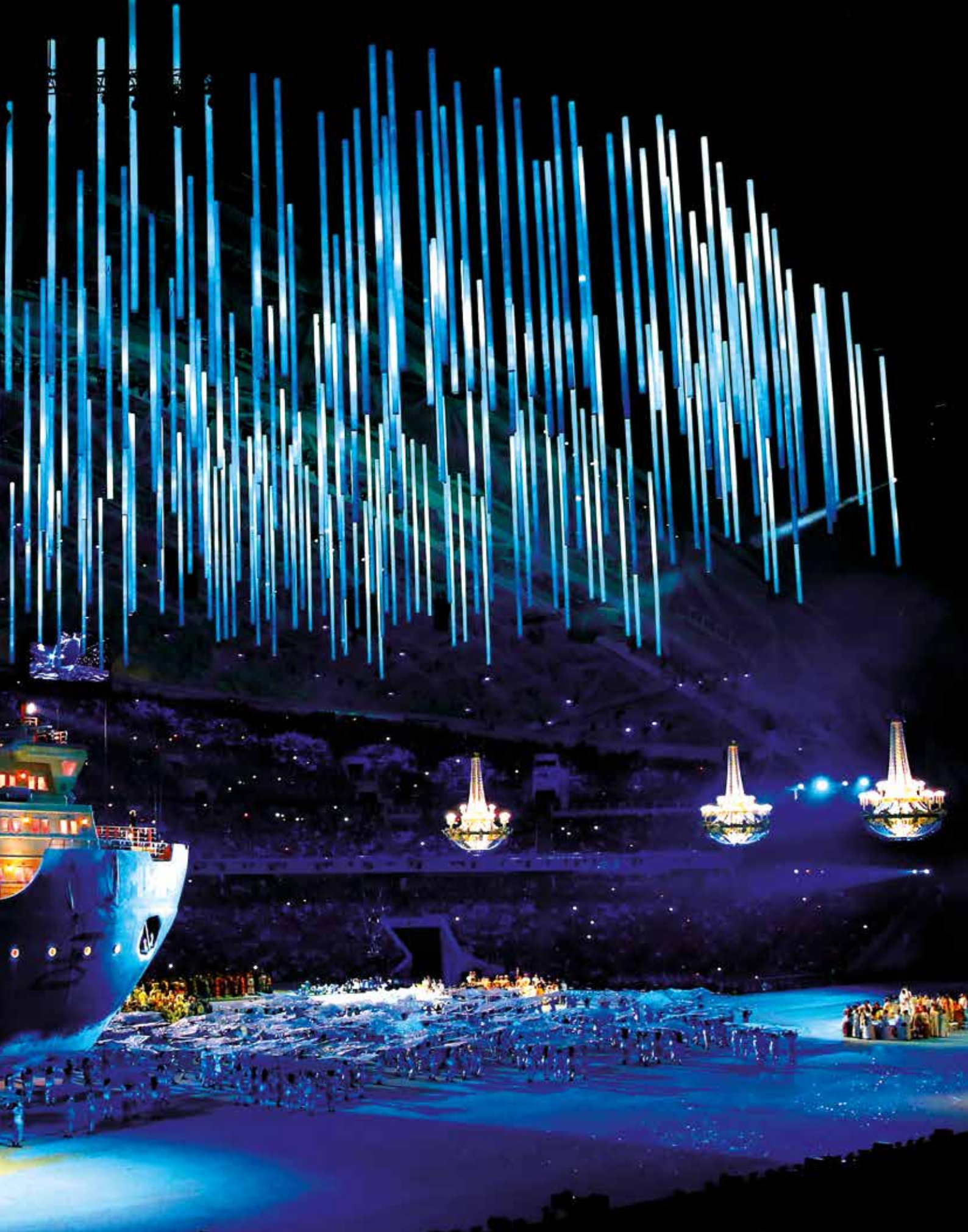

Sochi Winter Olympic Games

RES - S6 Media Server

Tiger Touch II



# Ai R SERIES SERVERS



## Infinity R Series Servers

The Ai R4 and R8 offer 4 and 8 display port/DVI outputs and up to 4 layers per fixture group, with top spec, fully featured Miami licences.

Hardware includes the latest generation motherboards supporting PCI-Express Generation 3.0, AMD Gen 3 Graphics Cards and an Intel PCIe SSD module with 1.2TB capacity.

Ai R4 & R8 servers offer MIDI Timecode inputs and supports ArtNet and CK Ki-Net output protocols.

### Infinity R4 & R8 features

- Smooth playback of up to 8K media using the AiM Codec
- Up to 4 or 8 full 1080p HD outputs
- Soft-edge blending of multiple projectors
- Timeline, Timecode Sequencer
- Support for 3D displays
- Build and create in the 3D Stage Visualiser
- Remote vertex adjustment
- Map and warp onto any 3D surface
- Video map onto any moving scenery
- Intuitive modular LED support
- Configure multiple systems as Master or Slaves
- Internet and iPad remote control (via VNC)
- Salvation node based engine
- Supplied pre-installed with an extensive Media Library of 320 HD AiM clips

### Capture input options

- Pro 1: 1x DVI/VGA input
- Pro 2: 2x HD/SDI inputs
- Studio 2+1: 1xDVI/VGA and 2x HD/SDI\*
- Studio 4: 4x HD/SDI inputs\*

## Your production deserves the best content



Get state-of-the-art content by downloading clips from our online media lounge shop at [contentshop.avolites.com](http://contentshop.avolites.com)  
All Ai Infinity servers are supplied pre-installed with an extensive stock content library of 320 HD AiM clips.

## Ai Infinity RX4 & Infinity RX8 Servers

The multi-award winning Ai Infinity server is the perfect choice for your most demanding video projects. The RX4 and RX8 have programmable, EDID managed, WUXGA (1920x1200) outputs. Each is digitally amplified to give you a preview and production output over DVI.

The back panel is full of I/O connectors, including LTC timecode input, 2 x Gigabit Network ports for connecting to Artnet networks, MIDI in & out ports, 4 lines of DMX, Audio I/O, Genlock – essential for TV projects, and 2 x sync network connections to guarantee vertical sync across multiple systems.

The front 7 inch colour touch screen shows the Ai 3D visualiser, this gives you networked control of your whole show from one integrated and intuitive interface, no matter how many outputs you need.

### Ai Infinity RX4 & Infinity RX8 features (Additional to the R-Series & S6)

- Internal EDID Management for each output
- Hot swappable rear DVI connections
- Integrated front panel touch screen interface
- Genloc Camera Sync (option on RX4, Standard on RX8)
- LTC Timecode Input
- 4 DMX outputs
- Artnet and KiNet output protocols
- Anti Shock & Floating Sub Frame construction





The Ai R6 is our most powerful server system. It offers a maximum of 6 Display Port / DVI outputs. They feature the latest generation motherboards supporting PCI-Express 3.0, the fastest AMD Graphics Cards and newest high speed PCIe 3.0 SSD drive with 1.2TB capacity. All systems are supplied with a fully featured Ai Miami licence which allows for approx. 16 media layers, separated between 1-16 fixture groups.

## Realise your most ambitious creative visions

### Market Leading Features

- Smooth playback of up to 8K Media (using AiM Codec)
- Multi layer 4K media playback (up to 4 layers)
- Maximum output resolution of 4k per output
- Up to 6 full 1080p HD outputs simultaneously
- Approx. 16 media layers in any configuration
- Soft-edge blending of multiple projectors
- Timeline, Timecode Sequencer
- Support for 3D displays
- Build and create in the 3D Stage Visualiser
- Remote vertex adjustment
- Map and warp onto any 3D surface
- Video map onto any moving scenery
- Intuitive modular LED support
- Configure multiple systems as Master Slave
- Internet and iPad remote control (via VNC)
- Salvation node based engine
- Also available with 1 x VGA / DVI + 2 x HD / SDI capture inputs or 4 x HD / SDI capture inputs

### Technical Specifications

- Maximum display port output resolution DisplayPort output is 4096 x 2160 @ 60 Hz
- Capture Input options: 1 x DVI and VGA & 2 x HD-SDI or 4 x HD SDI
- Supports Apple™ Pro Res 4444 codec at 4K
- PCI Express Gen 3 Motherboard
- PCIe SSD storage (1.2Tb)
- Dual Intel i7 six core processor (24 simultaneous threads)
- AMD's formidable W9100 gen 3 graphics cards
- 8Gb of ultra fast RAM
- High capacity, heat-pipe based, low speed and low noise CPU cooler
- 60 GB SSD for system OS
- 850 W auto ranging PSU
- Stereo Audio Output and Input
- 2 x ethernet 1 Gbit connection RJ45
- 3 USB inputs on the front panel and 3 x USB inputs on rear panel
- eSATA interface on the rear panel
- Provisions for 19" captive full length, Accuride rack slides
- Sturdy rack ears with integrated handles
- Provision for security cable attachment

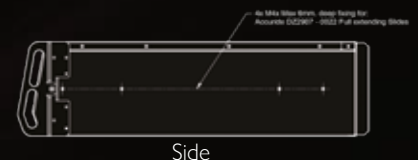
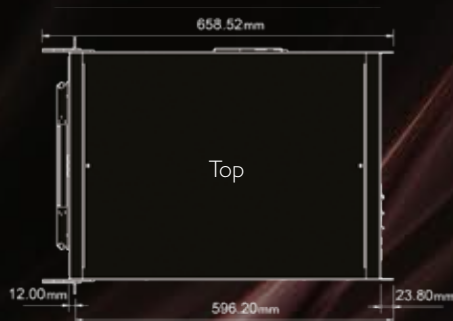

### Colour banding is history

Our revolutionary AiM Codec offers virtually un-compressed quality with smooth playback of up to 8K resolution media. AiM is a cross platform Quicktime codec available exclusively to Ai users at no additional cost for use in any Quicktime capable application.

This un-paralleled playback performance has been made possible through the use of the latest GPU technology bred for the gaming industry but now re-developed with the support of AMD and Nvidia exclusively for Ai.

# Ai SOFTWARE LICENSES

Childish Gambino by Moment Factory



## Ai – The Industry’s Most Powerful and Flexible Media Server

Ai is the application running within Avolites Media’s cross platform family of products, distilling 25 years of engineering design expertise with world-class show production skills.

Winner of both the PLASA Award for Innovation and the Live Design Projection Product of the Year award, the Ai media server uses this combined experience to produce a unique “Production based Workflow” offering the tools and features for faster delivery of even the most complex shows.

Features such as real time 3D project visualisation, an easily reconfigurable Node Based Engine and AiM, the industry leading codec make the Ai server a clear choice for any video, projection or LED mapping project. Ai servers also incorporate elegant multi-timelines, extended DMX/Artnet control as well as live video playback “Busking”.

### Ai Software Licence Keys

#### Run Ai from your laptop and edit on the go!

A full range of Ai licence levels are available as a software only solution. Licence Keys allow owners the flexibility to run the Ai media server software on their own servers or powerful laptops. Edit on the move and arrive with everything you need by running Ai from your 3D capable laptop.

The entry level ‘Anjuna’ licence includes Live Map, the Ai 3D Mapping engine and Timeline.

Bondi, the standard-level licence offers up to 4 full HD outputs, increased canvas resolution, 128 Artnet universes and up to 18 layers.

Miami, the advanced licence as found in the S-Series and Infinity Servers, offers 8 full HD outputs, a max canvas of 8,192 x 4,096 and up to 32 layers with CSV Import and Automation Support for large and complex productions.

For full Ai software licence options, please refer to: [www.avolites.com/products/video/software-licences](http://www.avolites.com/products/video/software-licences)



Ai pre-visualisation | Finalised live show  
Bon Jovi “Because We Can” - World Tour



The Arcadia Spider at Ultra on the Resistance Stage - Miami 2016

Two Sapphire Touch Lighting desks (Main & Backup), a Quartz - SFX Desk  
2 x Ai EX8 - Main and Back up Servers ( 2 x projectors 1 x LED installation)



# Ai FEATURES

## 'Supercharged' New Software

Building on the already impressive, award winning versions of Ai we have added even more new features to continue to deliver the 'everything you always wanted' in a media server ethos.

Ai V8 won Live Design's 'Projection Product of the Year' and the PLASA 'Innovation Award'; Ai servers combine 36 years of engineering design

### Output Configuration Page

The Output Configuration page allows the user to configure all parameters of their outputs using a unique UI for each Fixture Group tailored to the requirements of the Fixture. All of your video outputs and Artnet output can be configured on this page. It includes simple yet powerful tools for LED screen configuration, a navigable mapping editor for projection mapping and an Artnet Pixel mapping system. You can also apply soft edge blends and use Ai's Auto Map feature from this page.



### Surface Modelling Page

This page gives the non 3D application user the capability to create and edit 3D stage sets. It combines the best bits of Max, Maya, Blender etc. But with easy access to features designed specifically for our market like linear and radial repeat for object geometry. The user can flip between the new Surface Modelling Mode and Stage View Mode to instantly see how the screen you're designing fits with the rest of the stage.



### Patch Editing Page

The journey to allow novice to intermediate users to configure their show without using the node based environment is now complete. Acknowledging that there is unrivalled power and flexibility in the node based capabilities of Ai, the node based interface has been refined to allow users to feel more comfortable using it.

The Node based interface is now shown within the Ai User Interface window rather than in many sub windows. It is displayed in a pseudo 3D style which animates to zoom in when you enter a sub patch. We have also added the capability to zoom into modules giving you the option to work as small or large as you require.



and world-class show production experience in a unique "Production based Workflow". Ai offers the tools for faster delivery of even the most complex shows.

These are some more of the remarkable features that allow the award winning Ai media servers to enable such breath-taking visual environments.

### Automated Media Distribution

A function found within the System Settings window which allows up to 16 folders to be shared across the network. This automates the process of content distribution between multiple networked systems allowing media files or project assets to be auto synced between Ai servers.

### Performance Improvements

The Ai developers have made a massive improvement in the performance of Ai V8, optimising the render engine again to offer around a 50% improvement in video throughput using our AiM Superstream codec. Performance whilst live compositing high resolution background layers with low resolution foreground layers has also been much improved.

### Native HD SDI Input and Output

Support for up to 8 x 1080p HD SDI inputs or up to 8 x 1080p outputs or 2 x 4k outputs as an option on the Ai S series systems. The same cards can be used as input or output (in groups of 4). The outputs are frame synchronised so four 1080p outputs can be used as a single 4k feed on four HD/SDI cables.



### Camera Based Automated Warp and Blend

Ai offers a revolutionary camera based warp and blend feature. This allows the user to configure a large projection screen surface across all available video outputs on the system using our recommended webcam or ethernet camera and custom software to automatically calculate the required warping and blending of the outputs.



Multiple servers are also supported in the automated warp and blend process using an IP camera. This allows blends across huge surfaces. Curved surfaces, domes and flat screen arrays are all supported. This feature comes as standard with all Ai products and Software Licences.\*

### Editable Scene Triggers

Ai V7 introduced Scene Triggers which allowed you to store a pre-set state of all layers and attributes that could be recalled at the touch of a button. Ai V8 makes the scene triggers editable so that you can configure or remove triggering elements. This allows the user to decide exactly which aspects of the system the scene trigger will control.

\*Not included with Anjuna

## Performance Units

V8 introduced the notion of 'Performance Units', allowing you to gauge how hard you're pushing the system. The user interface will show the user a power bar style meter which will indicate the load that the system is under. As you add more layers and more outputs the power bar will decrease according to the capabilities of the system.

The Performance Units indication system will tie in with the marketing of the systems so that when you buy an Ai server you will know how many performance units the system is capable of. We will also publish a corresponding guide to what a performance unit is.



In summary, for those who are technically minded, one Performance Unit is equal to one Million pixels of data being transferred over the PCI express bus twenty five times per second. Our Third Generation systems such as the S4, S8, S6 and the EX4 & EX8 will support an absolute maximum of thirty two performance units when running Ai. That is almost 1 Billion pixels per second.

## User Customizable Effects

Ai's Effects system (SVFX) allows users to use the node based programming system to create their own effects and add them into the system. These effects can utilise the Salvation set of tools and input/output modules along with GLSL, Java script, MIDI, the list goes on and on. In fact, pretty much any of the other features of Ai can be plugged into your own customizable effects. This effects system has proven to be so efficient that we have converted all of our existing effects library to this standard. With every new version of Ai, the library of effects keeps growing.

## User Customizable Blend Mode system

Using the same system (SVFX) support has been added for user customizable blend modes. We have re-written the current set of blend modes to use this approach and we make a template available for any user who wishes to use this system to create their own blend modes.

## Layer Reference Module

Pull in media from anywhere in your mix - this module allows the user to reference a texture from a specific fixture and layer. This offers significant performance improvements when a user needs to play the same media out onto multiple screen surfaces or onto multiple layers.

## AiM Multi-threaded Encoder

The AiM Quicktime encoder now supports multi-core compression. This means that the AiM conversion process can now be done in faster than real time for HD footage and close to real time for 4k media on high spec systems.

## Interface Updates

New features and a constantly developing software require updated ways to control them. Including an intuitive page widget, a more intelligent layer controller which re sizes automatically, live update of controls from ArtNet sources and extra parameters added to the ArtNet personality.

## Audio Engine

Ai's audio engine now allows the playback of samples at any frequency as well as the ability to adjust the playback speed in real time. An audio fader has been added to the layer controls along with the mute button, both of which can be controlled locally or remotely.



## Dynamic Content Page

This page gives quicker and easier access to using patches during your show as well as providing a streamlined approach to their creation when using the supplied templates. Any combination of modules, GLSL and Java can be used to create real-time audio reactive content, live text and generative imagery.



## Syncgroups

Syncgroups offers a solution when you need to ensure that multiple clips are being played in synchronicity without the inflexibility and preprogramming traditionally associated with timecode. Set one clip as Source and others as Listening and all clips will progress a frame when when the Source does. With support for multiple Syncgroups, this function can work within a single machine or across a group of networked servers, giving you greater flexibility in show performance.



## Capture Support

Ai now supports MSEX streaming directly into Capture. Choose from individual layers, screen fixture mixes or even your entire 3d visualization and apply them to fixtures within Capture to get a true view of your lighting and video working together.



## AiM Codec

Ai's own AiM is a revolutionary codec which makes use of hardware acceleration from the graphics card to ensure smooth playback of high resolution media whilst maintaining exceptional image quality.

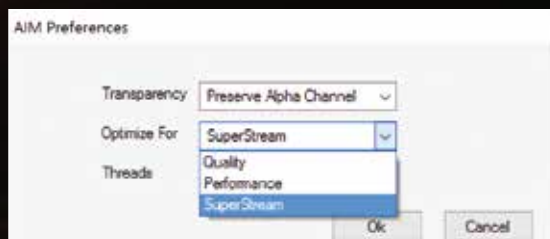



“

My first ever experience on an Avo console was in 1987 on a Rolacue 30, the build quality and ease of programming hooked me right away.

Avolites provided control for our major arena tours; Justin Timberlake Sexy Back World Tour, Alicia Keys, Kylie Minogue X Tour and the Coldplay X&Y Tour, just an amazing console which revolutionised programming for me.

An unbroken partnership with the finest team I have ever had the privilege to work with, and never, ever once have they ever let me down, not a single show ever failed to go up on time.

**Bryan Leitch from Mirrad**

”

#### Glastonbury Main Stage

792-strong par can rig controlled by 16 x Avolites ART2000 48 way 16A Dimmers  
and 2 x Avolites Power Cubes

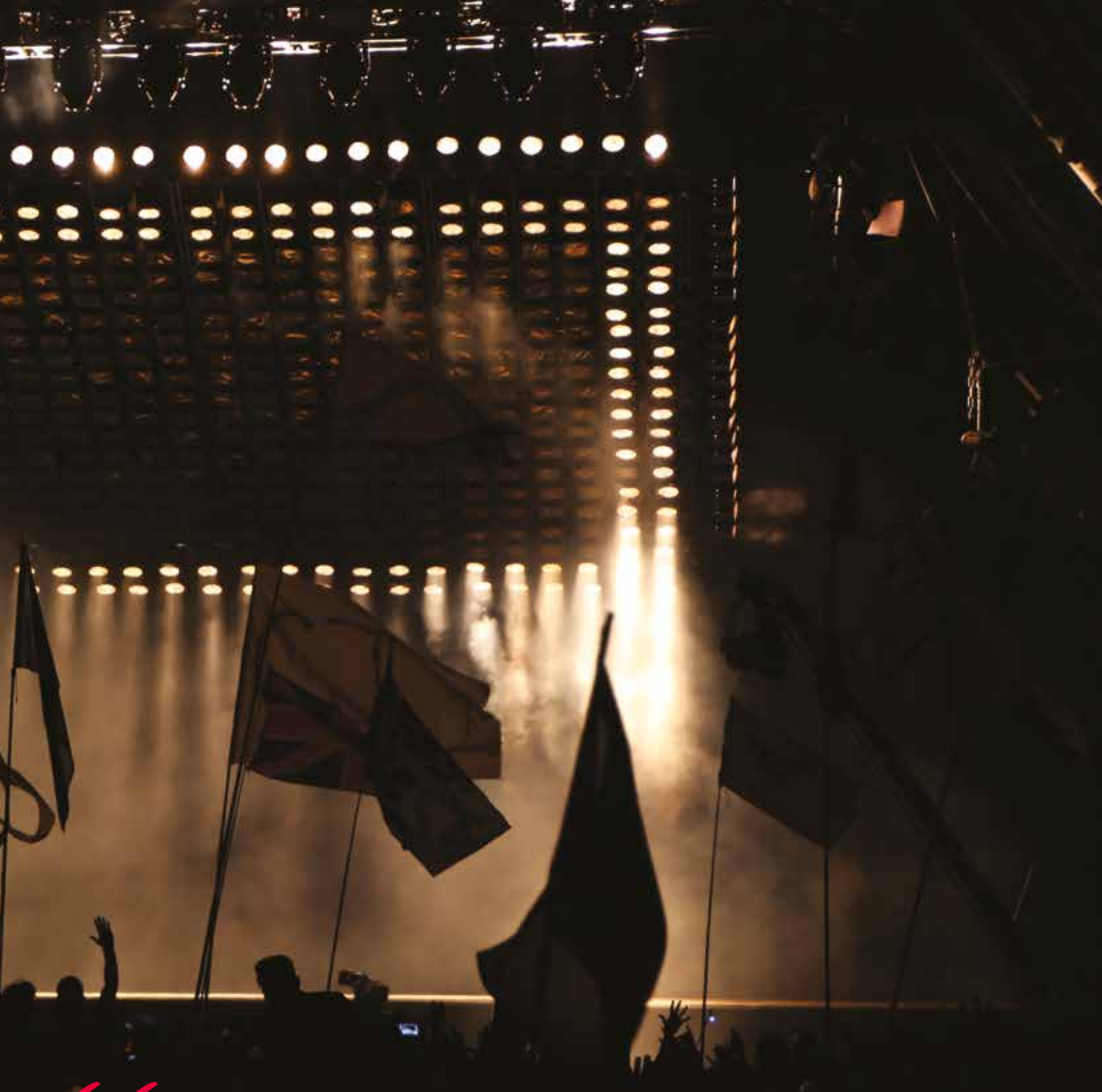

“

The products created and built by AVO have certainly enabled Hawthorn to deliver a huge variety of work during the 28 years we have used AVO equipment. From the latest Ai servers, desks with features and capabilities not even dreamed about at the start, to more fundamental dimmers, hot power with rugged use and flexible patching is such an industry favourite AVO is synonymous with lighting and its control.

**Martin Hawthorn from Hawthorn**

”

#### Glastonbury Main Stage

792-strong par can rig controlled by 16 x Avolites ART2000 48 way 16A Dimmers  
and 2 x Avolites Power Cubes

# ART2020



The ART2020 was designed with contributions from industry leading users and companies combined with 16 years of ART2000 and 40 years of Avolites dimmer knowledge to create a flexible and capable distribution and dimming system.

There is no need to have separate mains distribution or DMX splitters making set up times faster and lowering the number of individual components needed to put a show together.

The available modules are 12 x 16A RCBO dimmer, 12 x 16A RCBO distribution circuits or 12 x 16A RCBO contactor module to provide switchable mains to fixtures. The modules are freely interchangeable by the user.

The main input and the loop-out connectors are protected with an electronically adjustable MCB and RCB combination, allowing the breaker parameters to be controlled easily and comfortably from the dimmer user interface.

The breaker controls enable the user to coordinate MBC and RCB breakers in the larger system to assure isolation of faults, and prevent large scale outages during live events.

The overcurrent range can be selected on both breaker combinations as 125, 160, 250 and 320A, and the RCB differential current from 30mA, 100mA, 300mA, 1A, 3A, 5A and 10A as well as the RCB delay ranging from 20mS to 10 seconds in 10 steps.

The main and loop-out breaker electronic settings are a vital tool to assure compliance with new regulations for temporary electrical systems that are being enforced more and more.

The ART2020 is fitted with a comprehensive set of safety and reliability features which includes the ability to test the connected mains before the system energizes, over-voltage or a missing neutral connection will

not allow the system to energize. The control system is supplied from all three phases at the same time.

Clear indication lights are provided for the mains input both on the front and near the mains input and loop-out connectors to show mains connection status and if the loop-out is energized.

The three phases and the neutral current are measured and displayed, as well as the individual main and loop-out phase and neutral currents. The system can also display Var and Powerfactor which are important variables when working with generators.

The differential (earth leakage) current for the main and loop-out connectors as well as the total differential current is displayed along with the headroom actually setting headroom.

The dimmer is fitted with a Wieland ST17 (2-pin) or ST18 (3-pin) patch system comprising of 120 circuit outlets and up to 20 multi circuit outlets like the 19-pin and 6 or 8 circuit Harting.

The patch is located on the top of the rack to ensure it is easily accessible. The layout is intuitive and flexible with four outlets for the first 12 circuits and two outlets for the remaining 36 circuits. Six single outlets for the fixed mains are provided. The patch has a switchable patch light to allow working in the dark.

The separately supplied ST17 patch leads are fitted with a custom Avolites clip to retain the patch leads in the patch during transport. The high retention force of the ST18 patch does not require a clip.

The familiar load test facility is provided, which is battery operated, as well as the new load tester that can test a whole multi-core at once for connected load and earth faults. The tester is battery operated to allow testing before the mains connection has been provided, and is six and eight channel multi-pin outlet standards compatible.



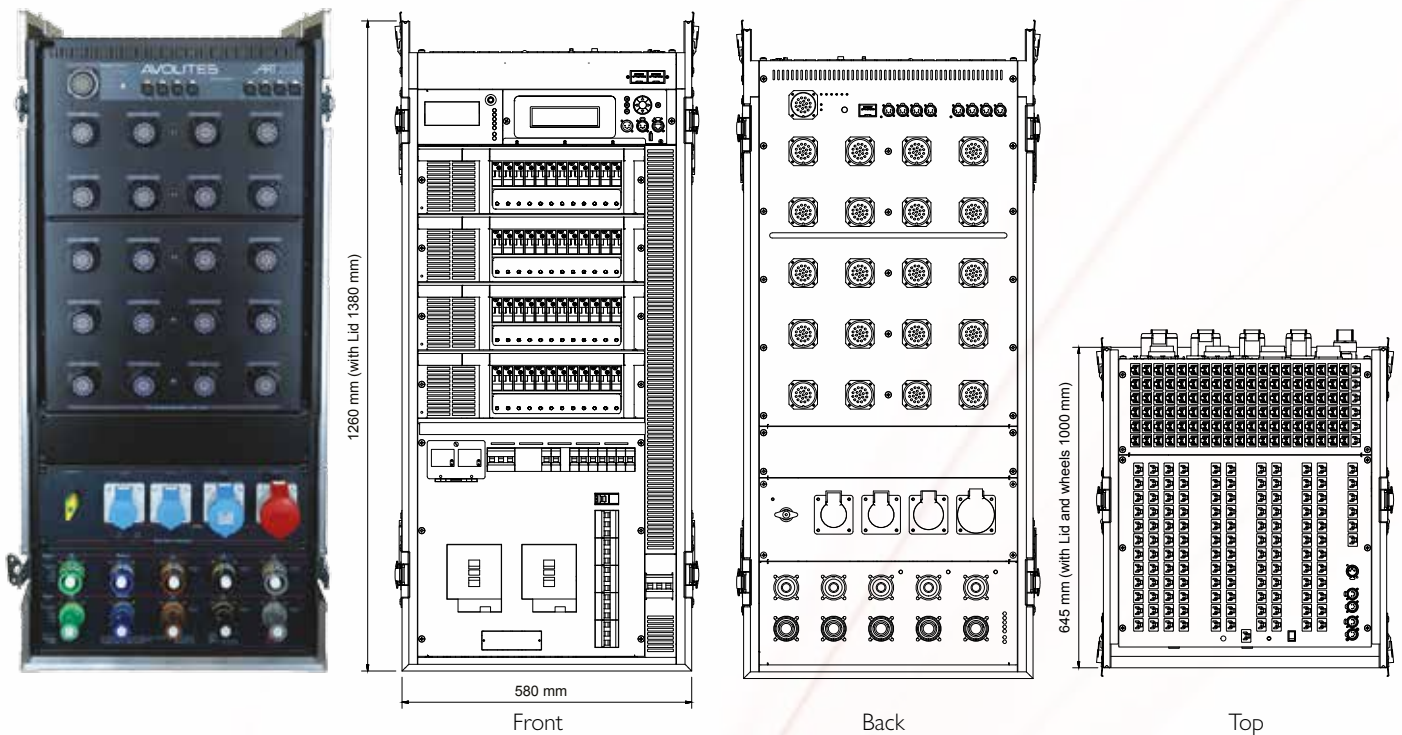

The Dimmer modules have 'load check' indicators for each dimmable channel to give a positive indication that a load is present and the local test fader on each dimmer channel to ensure that you can easily check the connected load without having to use a console.

The multi-functional DMX distribution can act as a dual DMX splitter with four outlets for each of the two DMX-512 5-pin XLR inputs. The same splitter outlets can be driven from Art-net or sACN generating two independent universes.

The ART2020 system can be provided with data either through a single DMX-512 5 pin XLR connector or additionally with ethernet either using Art-net or sACN protocols. The two data inputs can be HTP merged splitter. The user can select to use one DMX-512 5-pin XLR input as an input to the dimmer, allowing for two DMX 5-pin inputs to be merged.

The Dimmer supports a full range of control features such as soft patch for each channel, simple start address for a universe, curve, pre-heat and proportional limit setting per channel.

A host of information and diagnostics tools are provided, like isolated level data for each data input, and LED indication that Art-net or sACN universe data is present for the two splitter universes. This all assists the user in the complex world of mains and data distribution.

The ART2020 is supplied in a custom flight-case with wheels on the back panel, and three lids with ergonomically placed handles. The rack has RGB LED strips incorporated to aid working safely in dark environments. The LEDs can be set to any of the nine colours and when the system requires user attention the LEDs can change in colour to clearly indicate which rack. The module RCBO breakers are discretely lit to allow the breaker state to be seen in the dark.

- 48 dimmer or distribution circuits
- 6 additional Direct out circuits
- All final circuits are protected with a European made RCBO (30mA/20mS)
- Main System input breaker with adjustable trip current of 125, 160, 250 and 320A
- Separate Loop Out Breaker adjustable trip current of 125, 160, 250 and 320A
- Loop Out and System input RCB protection with Current and Trip Delay adjustment
- Overvoltage protection during start-up
- Clear indication of Phase, neutral and differential currents and Voltages
- Integral multi pin connector load tester
- Ergonomic layout and User Interface
- DMX-512, Art-net and sACN control input
- Build in two Universe Art-net and sACN Node with 4 outlets per universe
- USB Phone Charging point
- RGB Rack lighting, Backlit switches and illuminated Breakers
- Dedicated FOH 32A RCBO and Connector
- Fast test function with local faders
- Designed to meet new standards in temporary electrical systems

# ART2000 SERIES



ART2000 T4 48 X 16A

Providing a complete solution to Dimming, Moving Light Power and Data distribution.

No need to have separate mains distribution or DMX splitters making set up times faster and lowering the number of individual components needed to put a show together. The ART2000 controls up to 48 individual channels using four plug-in modules of 12 channels each.

The available modules types are:

- 16 amp 12 channel continuously rated dimming module with 250µs rise time and local controls
- 16 amp 12 channel switch module for powering moving lights or other equipment
- 16 amp 12 Channel Contactor module, allowing remote switching of ballasted fixtures
- 48 channels at 16 amps per channel
- Channels can be specified as dimmable, manual switch or contactor
- Excellent noise suppression with 250 µs chokes
- 100% duty cycle
- Single Pole and Neutral Disconnect breakers are available

- C-type breakers allow for high inrush currents
- Three Phase and Single Phase operation (requires option)
- Individual faders for each channel for use as channel test, scene setting or for controlling the twelve on-board memories
- Analogue Volt & Amp meter as standard. Digital combined V&A meter optional



ART2000 T4 48 x 16A ST18

# ART2000 SERIES



ART2000 T4 48 X 16A ELDC



ART2000 T4 24 x 32A



## Film and TV Dimmers

The ART2000 range has been developed to meet the growing and changing demands of the television, film and industrial show and exhibition lighting, where the use of dimmable fixtures is becoming an increasingly popular, cost effective method of lighting these specific environments.

Within the ART2000 T4 range there are two channel capacities, 24 x 32 amp, 12 x 63 amp and 14 x 16 amp. The channel breakers are type C allowing for high inrush current associated with the larger capacity luminaires. Both channels sizes are continuously rated at 40°C ambient, and use custom made noise suppression chokes with a rise time of 240 µs.

The ART2000 system can also be fitted with Earth Leakage Breakers that can be individually disabled per bay by the user, a "No Volt Return" circuit assures that the RCB function is maintained after each power cycle or re-hire, therefore adhering to the future recommendation of the BS7909 standard for temporary mains distribution systems.

The 'Load Check' indicators for each dimmable channel give a positive indication that a load is present and the local test fader on each dimmer channel ensure that you can easily check the connected load without having the use of a console.

The design incorporates full monitoring and status feedback via the backlit LCD display. Static state environments are catered for using the front panel control faders. Further 12 memories can be recorded for later replaying either as a simple show in the event a console is not available.

Other features include full DMX patch and merge (2 DMX lines), dimmer curve and limit selection per channel, power OK indicators. Analog Volt and Amp metering or optional Digital metering.

- The direct output panel for the 32 A channel has 24 x Ceeform 32 A single phase connectors.
- 8 x 7-pin XLR Ceeform 32 A 3 phase 3 neutral connector in parallel to each 3 channels can be added as an option, which is particularly suitable for sub-distribution on set, thereby reducing cabling runs and cost.
- The direct output panel for the 63 A channel has 12 x 63 A Ceeform single phase connectors fitted.
- The mains input can be on Single Pole Connectors such as Powerlock, Camlock with an optional Loop out.
- ELDC breaker system option available

# ART2000 SERIES



ART2000 T4 12 X 63A

The mains input can be on Single Pole Connectors such as Powerlock, Camlock with an optional Loop out.

The 'Load Check' indicators for each dimmable channel give a positive indication that a load is present and the local test fader on each dimmer channel ensure that you can easily check the connected load without having the use of a console.

The design incorporates full monitoring and status feedback via the backlit LCD display.

Static state environments are catered for using the front panel control faders. Further 12 memories can be recorded for later replaying either as a simple show in the event a console is not available.

Other features include full DMX patch and merge (2 DMX lines), dimmer curve and limit selection per channel, power OK indicators. Analog Volt and Amp metering or optional Digital metering.

- ELDC breaker system option available

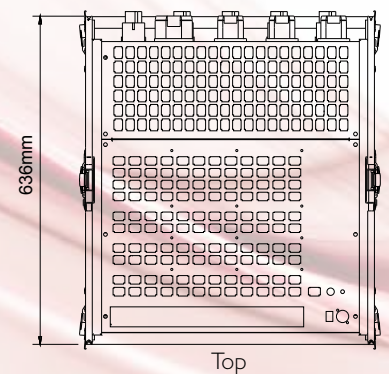
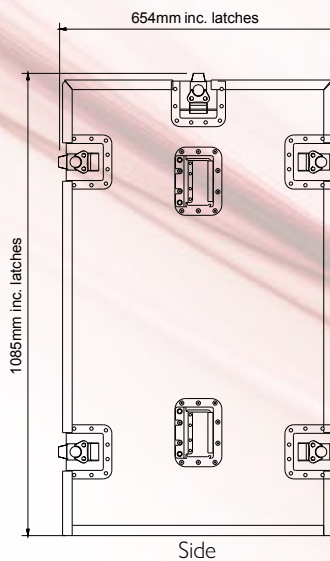
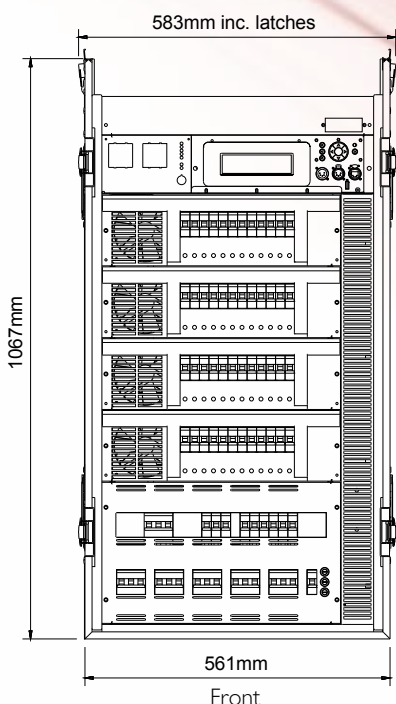

ART2000 T4 dimensions - other versions may vary

Avolites Film and TV dimmers have been used on The Harry Potter series, The Lord of the Rings, Avengers Assemble, James Bond, Game of Thrones, Mission Impossible, and many more...



## A Complete Dimming, Mains and Data Distribution Solution in One Box

The compact box with proven ART2000 technology is quick to set up. It boasts 12 dimmer circuits at 10amp each, 6 combined dimmer and fixed mains.

- Dimmer and distribution channels – 10 A C type ABB breakers
- Distribution channels 16 A C type ABB breakers (5 - 10x I nominal inrush current)
- Captive Mains tail of 1.2m H07R 5x 10 mm<sup>2</sup> fitted with a 63 A 5-pin Cee connector
- Mains supplies either 63 A 3phase+N TN-S or 63 A single Phase +N
- Mains inlet breaker 63 A D type ABB breakers (10 - 15x I nominal inrush current)
- Three individual single phase 63 A 30 mA residual current breakers to protect operators. Each RCB protects one phase, therefore increasing the selectivity of the RCB protection. (BS7909 requirement)
- Mains breaker is a four pole unit that also protects the Neutral wire which is important in case of single phase operation
- Socapex or Harting output connectors available
- Flight-case and dimmer provide for easy storage of this cable
- Weight 43 kg

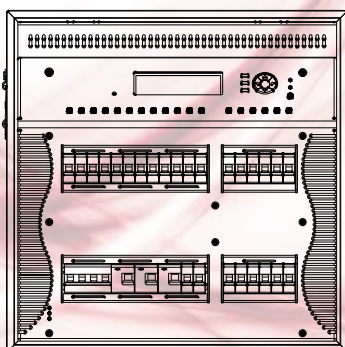

Front

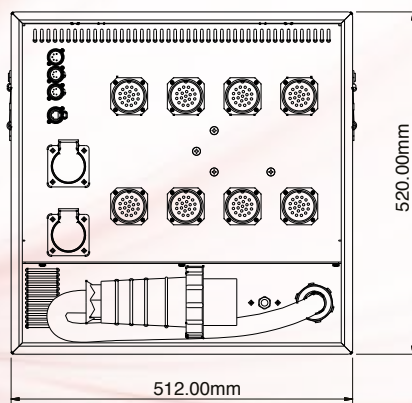

Back

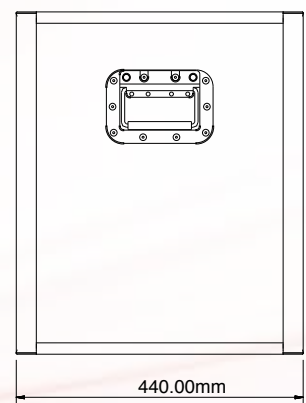

Side



Omnia by Hakkasan  
Caesars Palace, Las Vegas  
Infinity EX8, Sapphire Touch and Quartz

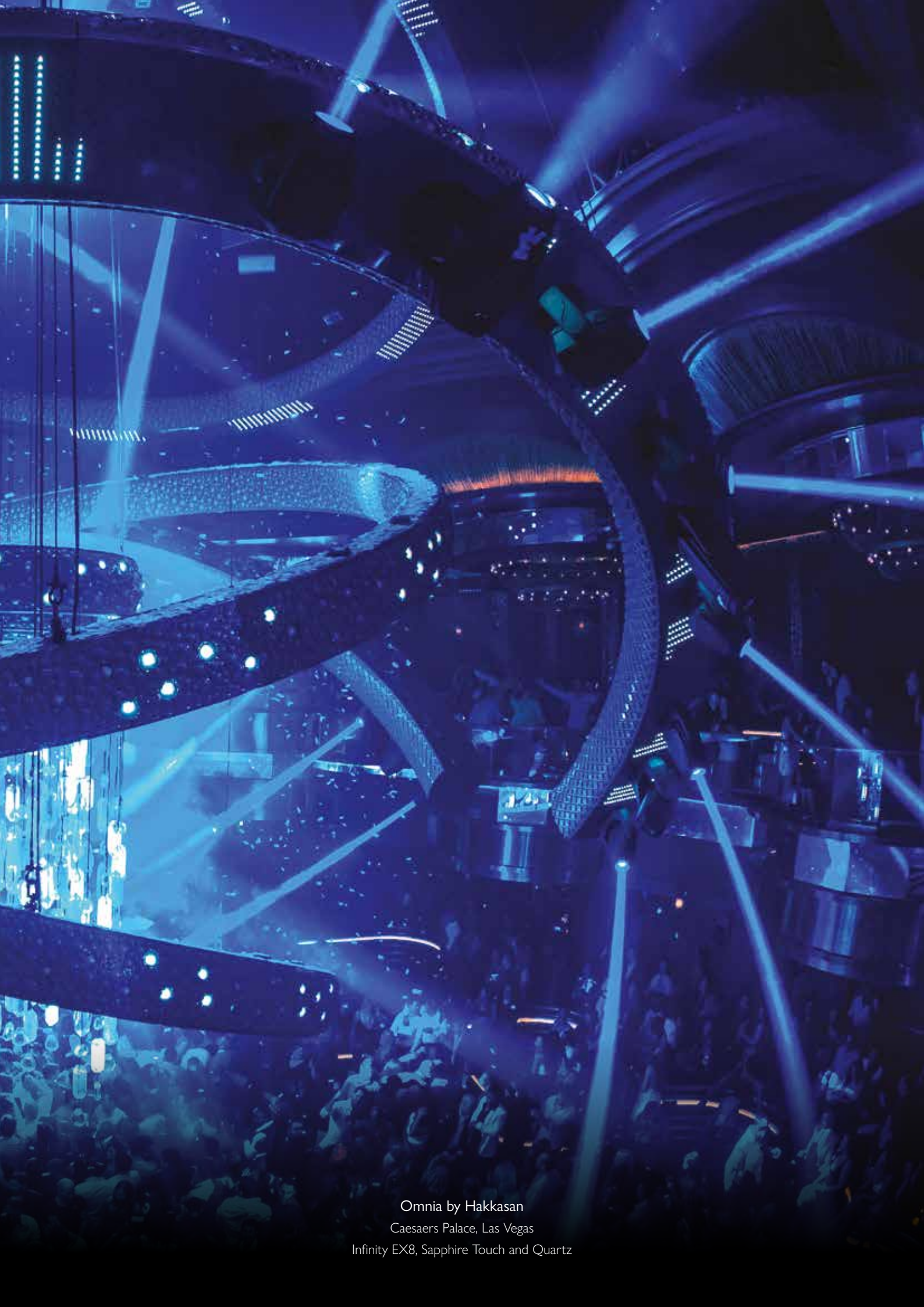

Omnia by Hakkasan  
Caesars Palace, Las Vegas  
Infinity EX8, Sapphire Touch and Quartz

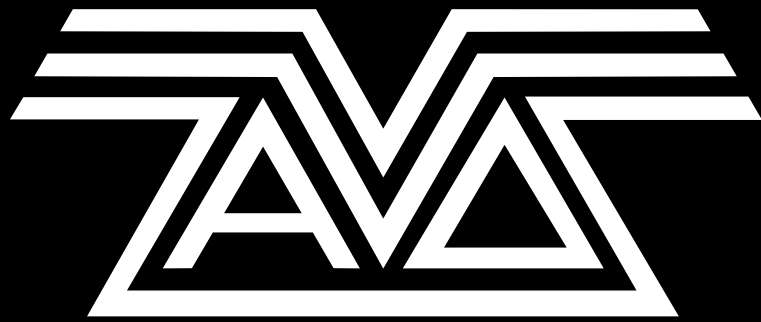

AVOLITES

CELEBRATING 40 YEARS OF  
TOTAL VISUAL CONTROL  
FROM ROCK TO OPERA

DESIGNED & MANUFACTURED IN THE UK SINCE 1976

